



Zástupce pro Českou republiku

FALCON CZECH s.r.o.

Osvoboditelů 2649

440 01 Louny

Telefon: 415 670315

Mobil: 603 50 60 77

info@falconczech.cz

www.falconczech.cz



FORZA[®]



HYDRAULIC









PULLERS



HYDRAULIC PULLERS:







Wide range of hydraulic extractors, specially designed to extract bearings, pulleys, gears, shafts and many other mechanical parts. Aimed at sectors such as naval, public works, automotive, aeronautical, railway and petrochemical industry among others.

HYDRAULIC PULLERS





	Hydraulic parts	95-96
	Extractores hidráulicos de alargaderas y patas	97-98
	Solid cylinder extractors	99-100
	Hydraulic Oscillating legs pullers	101
	Hydraulic self-centering pullers	108-111
	100ton puller trolley	112
	Hydraulic bolt puller	113
	Hydraulic internal pullers	114-117



CONJUNTOS HIDRÁULICOS

	Hydraulic set C1000	118
	Hydraulic set CP	119
	Hydraulic set CPA	120
	Hydraulic set CPN	121
	Hydraulic set XP	122
	Hydraulic set KP	123

PULLERS WITH HYDRAULIC COMPACT SPINDLE

	6&8 tons hydraulic ram pullers	124
	8 tons hydraulic ram pullers	125-126
	12 tons hydraulic ram pullers	127-129
	15 tons hydraulic ram pullers	130-131
	Hydraulic compact spindles	132



WHEN TO CHOOSE A HYDRAULIC PULLER?



In maintenance situations, there are parts such as bearings, pulleys, gears, shafts or bearings that are needed to be removed. Difficult access, tightening conditions and other factors make that these parts cannot be safely removed without the use of a professional puller.

These types of parts are most often found mounted on a machine, installation or vehicle. Forza offers fast, efficient, safe and gentle disassembly.

Forza pullers means high productivity, costs savings and long-term machine life. It is cheaper to buy a Forza puller than to pay for downtime costs and investment in new machinery.

When to choose a hydraulic puller?

Manually or mechanically a maximum nominal force of 4-5Tons can be reached, which it is not enough in many cases. The working position as well as the “physical limitations” must be taken into account. For this reason, we always recommend a hydraulic drive from 8 Tons upwards.

Hydraulic pullers are usually known by their capacity in tons, this capacity is generally proportional to the dimensions of the workpiece to be extracted.



HYDRAULIC PARTS

At Forza we are an Enerpac partner so we supply our extractors with their hydraulic equipment. It is also possible to buy only the mechanical part since they are compatible with any other hydraulic manufacturer.

The hydraulic part of the extractor consists of:

Hydraulic pump



The pump is the part that brings pressure to the cylinder. Forza supplies it together with the gauge and hose.

Hydraulic cylinder



The hydraulic cylinder which is the force creating part of the puller. It is a single acting cylinder with spring loaded return.

Hose



It leads the oil from the pump to the cylinder. Length: 1.8m

Gauge



It is very important to pay special attention to the pressure gauge and for your safety NEVER exceed 650Bar displayed in the gauge.

SERIE 00900 HYDRAULIC PARTS

00900

The 00904 and 00909 units do not include a pressure gauge and have solid cylinders.



Ref.	TON		Cylinder	Pump
00904	4	5,2	09041	009542
00909	10	14,0	09091	009542



Ref.	TON		Cylinder	Pump
00910	10	11,2	09101	09102
00918	20	16,0	09181	09102
00930	30	19,0	09301	09102
00952	50	43,0	09521	09522
00995	100	78,0	09951	09522

10 AND 100 TONS HYDRAULIC CYLINDERS



Single acting cylinder.
Industry standard in general.
Maximum pressure 700Bar.



Ref.	Stroke	Bolster thread (W)	Retracted height (A)	External diameter (D)	Internal thread	TON	Distance holes (U)	Thread hole (V)		Saddle
09101	42	2 3/4"-16UN	120	69	3/4" UNF 16h	10	50,8	5/16"-18UN	2,7	-
09181	49	3 7/8"-12UN	162	98	1 9/16"-16UN	20	82,6	3/8"-16UN	7,5	111857
09301	64	4 1/2"-12UN	178	114	1 13/16"-16UN	30	92,2	3/8"-16UN	10,5	113057
09521	76	6 1/4"-12UN	247	159	2 3/4"-16UN	50	130,3	1/2"-13UN	31,0	115257
09951	76	8 3/8"-12UN	254	212	4"-16UN	100	177,8	5/8"-11UN	65,0	119557

HYDRAULIC PUMP FROM 10 TO 100 TONS



Hand pumps with light and compact design.
Less pumping effort to reduce operator fatigue.
Internal safety valves to avoid overloads.
Two-stage operation on all models reduces pumping strokes by up to 78% compared to single-stage pumps.
Pressure gauge and hose included.
Maximum operating pressure 700Bar.



Ref.	Conection	Maximum Handle Effort (kg)	Total length	TON	
09102	3/8"-18NPTF	39	480	10,20,30	10,9
09522	3/8"-18NPTF	35	511	50,100	15,2
091202	3/8"-18NPTF	42	533	10,20,30	11,0

*The pump 09102 is one-stage. (Two-stage pump are available).



SEE MANUAL



SERIE 1000H 2 JAWS PULLERS' MECHANICAL PART

1000H



Mechanical part of serie 3000H.
2 external fixed jaws puller.



Bullet points

- Hydraulic mechanism: faster pulling with less effort.
- Point protector included for a better use.

Ref.					TON		Spare part	Accessorie
							Complete jaw	Point protector
1018H	260	280	105	370	20	20,0	102050	111837
1018LH	390	280	115	370	20	25,8	102060	111837

SERIE 3000H COMPLETE HYDRAULIC PULLER

3000H



2 external fixed hydraulic jaw puller.

Bullet points

- Hydraulic system: faster pulling with less effort.
- Point protector included for better use.



Ref.	TON		Hydraulic part	Mechanical part
3018H	20	36,0	00918	1018H
3018LH	20	41,8	00918	1018LH

SERIE 1100H MECHANICAL PART

1100H







Mechanical part of the serie 3100H.
These pullers combine with the 1200 splitters and are the safest way to remove pulleys without damaging them.



Bullet points

- These pullers can be used with plate jaws.
- It can be also used as push pullers with serie 1500 and 4700 internal pullers.
- Point protector included for a better use.

Ref.					TON		Internal puller	Splitter	Spare part		Accessories		Spare part
									Spindle	Plate jaw	Point protector	Complete extension	
1110H	300	260	115	280	10	7,3	1506H10 1507H10 4704H10	1204B 1206B	111083	112005 112006	111037	111080H	
1118H	265	345	140	370	20	17,5	1506H20 1507H20 4704H20	1206B 1208B	111883	112005 112006	111837	111880H	
1130H	284	440	180	480	30	35,5	1509H30	1208C 1210C	113083	113505	113037	113080H	
1152H	447	580	220	615	50	70,5	1509H50	1210D 1212D 1213D	115283	115005	113037	115280H	
1195H	600	700	340	760	100	168,3	-	1213E	119583	-	119537	119580H	

SERIE 3100H COMPLETE HYDRAULIC PULLER

3100H



Push puller with hydraulic part.
These pullers combine with the 1200 splitters and are the safest way to remove pulleys without damaging them.



Bullet points

- These pullers can be used with plate jaws.
- It can be also used as push pullers with serie 1500 and 4700 internal pullers.
- Point protector included for a better use.

Ref.	TON		Hydraulic part	Mechanical part	Internal puller	Splitter
3110H	10	32,0	00910	1110H	1506H10 1507H10 4704H10	1204B 1206B
3118H	20	51,0	00918	1118H	1506H20 1507H20 4704H20	1206B 1208B
3130H	30	71,0	00930	1130H	1509H30	1208C 1210C
3152H	50	143,0	00952	1152H	1509H50	1210D 1212D 1213D
3195H	100	21,0	00995	1195H	-	1213E



SERIE 1000HF 2 JAWS PULLERS' MECHANICAL PART 1000HF







Mechanical part of serie 3000H.
2 external fixed jaws puller
Point extension included:
-130789 extens 55mm
-131089 extens 85mm



Bullet points

- Hydraulic system: faster pulling with less effort.

Ref.					TON		Spare part	
							Point extension	Complete jaw
1010AHF	160	200	60	260	5	3,5	130789	101050
1010HF	160	150	60	210	5	3,1	130789	101050
1010LAHF	220	200	60	260	5	4,0	130789	101060
1010LHF	220	150	60	210	5	3,6	130789	101060
1020HF	260	250	60	345	10	12,0	131089	102050
1020LHF	300	245	60	345	10	14,0	131089	102060

SERIE 3000HF COMPLETE HYDRAULIC PULLER 3000HF

2 external fixed hydraulic jaw puller.
Point extension included.

Bullet points

- Hydraulic system: faster pulling with less effort.

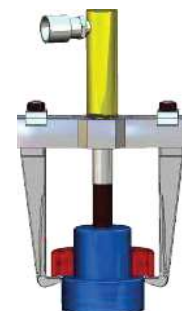

Ref.	TON		Hydraulic part	Mechanical part
3010AHF	5	21,0	00904	1010AHF
3010HF	5	20,0	00904	1010HF
3010LAHF	5	21,0	00904	1010AHF
3010LHF	5	20,0	00904	1010LHF
3020HF	10	32,0	00909	1020HF
3020LHF	10	35,0	00909	1020LHF

SERIE 1100HF PUSH PULLERS' MECHANICAL PART

1100HF







Mechanical part of serie 3100HF.
 Combines with 1200 serie of splitters.
 Combines with 1500 and 4700 serie of internal pullers.
 Includes point extension.
 -130789 extens 55mm.
 -131089 extens 85mm.

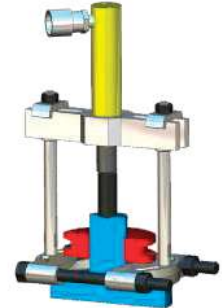

Bullet points

- Hydraulic system: faster pulling with less effort.



Ref.				TON		Accessorie	Spare part	
						Splitter	Point extension	Extender
1108AHF	190	250	260	5	3,2	1206B	130789	111080
1108HF	190	200	210	5	3,0	1204B	130789	111080
1120HF	255	325	210	10	9,4	1206B 1208B	131089	112080

SERIE 3100HF COMPLETE HYDRAULIC PULLER

3100HF



External hydraulic push puller.
 Combines with the splitters serie 1200.
 Combines with series of interiors 1500 and 4700.
 Includes point extension.



Bullet points

- Hydraulic system: faster pulling with less effort.

Ref.	TON		Hydraulic part	Mechanical part
3108AHF	5	21,0	00904	1108AHF
3108HF	5	21,0	00904	1108HF
3120HF	10	30,0	00909	1120HF



SERIE 1300LTH 2/3JAWS PULLERS' MECHANICAL PART

1300LTH





Mechanical part of serie 3300LTH.
 External 2/3 jaws hydraulic puller.
 Long jaws (3 holes).
 Point extension included.
 130789 extend 55mm.
 131089 extend 85mm.



Bullet points

- Hydraulic system: faster pulling with less effort.
- 3 jaw positions.
- Possibility of use with 2 or 3 jaws.
- The pull out improves thanks to the three jaws.

Ref.			TON		Spare part	
					Point extension	Complete jaw
1307LTH	225	240	5	3,5	130789	130760
1310LTH	400	350	10	9,5	131089	131060
1310XTH	480	405	10	11,9	131089	131066

SERIE 3300LTH COMPLETE HYDRAULIC PULLER

3300LTH



External 2/3 jaws hydraulic puller.
 Long jaws (3 holes).
 Point extension included.

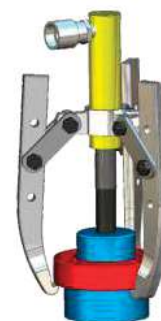

Bullet points

- Hydraulic mechanism: faster pulling with less effort.
- 3 jaw positions.
- Possibility of 2 or 3 legs pulling.
- The pull out improves thanks to the three jaws.



Ref.			TON		Hydraulic part	Mechanical part
3310LTH	400	350	10	33,0	00909	1310LTH
3310XTH	480	405	10	36,0	00909	1310XTH

SERIE 1300H MECHANICAL PART

1300H

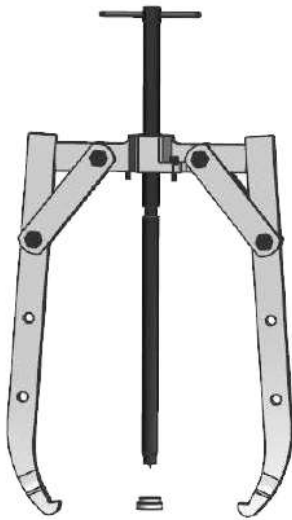

Mechanical part of serie 3300H.
External 2 jaws puller.
Long jaws (3 holes).



Bullet points

- 3 jaw positions.
- Point protector included for a better use.

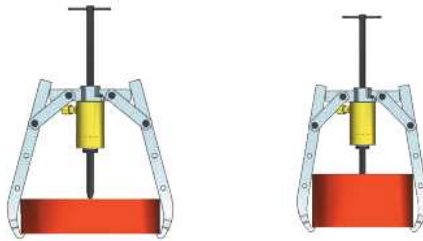

Ref.					TON		Spare part		
							Spindle	Jaw	Point protector
1318H	320	480	80	280	20	18,0	111883	131706	111837
1330H	410	650	100	325	30	30,0	113083	133006	113037
1352H	710	980	150	414	50	66,0	115283	135206	113037

SERIE 3300H COMPLETE HYDRAULIC PULLER

3300H



Complete puller: mechanical part + hydraulic part.
External 2 jaws hydraulic puller.
Long jaws (3 holes).



Bullet points

- Hydraulic system: faster pulling with less effort.
- 3 jaw positions.
- Point protector included for a better use.

Ref.	TON		Hydraulic part	Mechanical part
3318H	20	47,0	00918	1318H
3330H	30	65,0	00930	1130H
3352H	50	137,0	00952	1352H



SERIE 1300HX MECHANICAL PART 1300HX







Mechanical par of serie 3300HX.
External 2 jaws puller.
Long jaws (4 holes).



Bullet points

- 4 jaw positions.
- Point protector included for a better use.

Ref.					TON		Spare part		
							Spindle	Jaw	Point protector
1318HX	435	540	80	280	20	20,0	111883	131716	111837
1330HX	535	720	100	325	30	34,0	113083	133016	113037
1352HX	830	1080	150	414	50	72,0	115283	135216	113037

SERIE 3300XH COMPLETE HYDRAULIC PULLER 3300HX



Complete puller: mechanical part + hydraulic part.
External 2 jaws hydraulic puller.
Long jaws (4 holes).



Bullet points

- Hydraulic system: faster pulling with less effort.
- Point protector included for better use.
- 4 jaw positions.

Ref.	TON		Hydraulic part	Mechanical part
3318HX	20	49,0	00918	1318HX
3330HX	30	69,0	00930	1330HX
3352HX	50	144,0	00952	1352HX



SERIE 1300TH MECHANICAL PART

1300TH







Mechanical part of serie 3300TH.
External 3 jaws puller.
Long jaws (3 holes).



Bullet points

- 3 jaw positions.
- Point protector included for a better use.
- The pull out improves thanks to the three jaws.

Ref.					TON	Position		Spare part		
								Jaw	Spindle	Point protector
1310TH	310	360	60	176	10	2/3 jaws	9,0	131006	111083	111037
1318TH	320	480	80	276	20	3 jaws	23,0	131706	111883	111837
1330TH	410	650	100	325	30	3 jaws	40,0	133006	113083	113037
1352TH	710	980	150	414	50	3 jaws	87,0	135206	115283	113037

SERIE 3300TH COMPLETE HYDRAULIC PULLER

3300TH



Complete puller: mechanical part + hydraulic part.
External 3 jaws hydraulic puller.
Long jaws (3 holes).



Bullet points

- Hydraulic system: faster pulling with less effort.
- 3 leg positions.
- Point protector included for a better use.
- The pull out improves thanks to the three jaws.

Ref.	TON		Hydraulic part	Mechanical part
3310TH	10	34,0	00910	1310TH
3318TH	20	56,0	00918	1318TH
3330TH	30	73,0	00930	1330TH
3352TH	50	160,0	00952	1352TH



SERIE 1300THX MECHANICAL PART

1300THX



Mechanical part of serie 3300THX.
External 3 jaws puller.
Extra long jaws (4 holes).



Bullet points

- 4 jaw positions
- Point protector included for a better use.
- The pull out improves thanks to the three jaws.

Ref.					TON	Position		Spare part	
								Jaw	Spindle
1310THX	395	410	60	176	10	2/3 jaws	10,5	131016	111083
1318THX	435	540	80	276	20	3 jaws	26,0	131716	111883
1330THX	535	720	100	325	30	3 jaws	46,0	133016	113083
1352THX	860	1080	150	414	50	3 jaws	96,0	135216	115283

SERIE 3300THX COMPLETE HYDRAULIC PULLER

3300THX



Complete puller: mechanical part + hydraulic part.
External 3 jaws hydraulic puller.
Extre long jaws (4 holes).



Bullet points

- Hydraulic system: faster pulling with less effort.
- 4 jaw positions.
- Point protector included for better use.
- The pull out improves thanks to the three jaws.

Ref.	TON		Hydraulic part	Mechanical part
3310THX	10	34,0	00909	1310THX
3318THX	20	59,0	00918	1318THX
3330THX	30	91,0	00930	1330THX
3352THX	50	171,0	00952	1352THX

SERIE 1300THCO MECHANICAL PART

1300THCO



Mechanical part of serie 3300THCO
 External 2-3 jaws puller.
 Long jaws (3 holes).
 2 jaws body included.



Bullet points

- 3 jaw positions.
- Point protector included for a better use.
- The pull out improves thanks to the three jaws.

Ref.					Includes	TON		Spare part		
								Spindle	Jaw	Point protector
1318THCO	320	480	80	276	Body 131881 for 2 jaws	20	25,3	111883	131706	111837
1330THCO	411	650	100	325	Body 133081 for 2 jaws	30	44,5	113083	133006	113037
1352THCO	710	980	150	414	Body 135281 for 2 jaws	50	95,0	115283	135206	113037

SERIE 3300THCO COMPLETE HYDRAULIC PULLER

3300THCO



Complete puller: mechanical part + hydraulic part.
 External 3 jaws hydraulic puller.
 Long jaws (3 holes).
 2 jaws body included.



Bullet points

- Hydraulic system: faster pulling with less effort.
- 3 jaw positions.
- Point protector included for better use.
- Possibility of 2 or 3 legs pulling.
- The pull out improves thanks to the three jaws

Ref.	TON		Hydraulic part	Mechanical part
3352THCO	50	160,0	00952	1352THCO
3318THCO	20	59,0	00918	1318THCO
3330THCO	30	78,0	00930	1330THCO



SERIE 1300THXO MECHANICAL PART

1300THXO

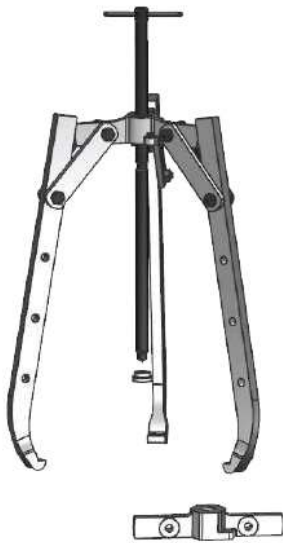

Mechanical part of serie 3300THXO.
External 3 and 2 jaws puller.
Extra long jaws (4 holes).
2 jaws body included.



Bullet points

- 4 jaw positions.
- Point protector included for a better use.
- 2 or 3 legs pulling.
- The pull out improves thanks to the three jaws.

Ref.					Includes	TON		Spare part		
								Spindle	Jaw	Point protector
1318THXO	435	540	80	276	Cuerpo 131881 para 2 patas	20	28,5	111883	131716	111837
1330THXO	536	720	100	322	Cuerpo 133081 para 2 patas	30	50,5	113083	133016	113037
1352THXO	860	1080	150	414	Cuerpo 135281 para 2 patas	50	104,0	115283	135216	113037

SERIE 3300THXO COMPLETE HYDRAULIC PULLER

3300THXO



Complete puller: mechanical part + hydraulic part.
External 2 and 3 jaws puller.
Extra long jaws (4 holes).



Bullet points

- Hydraulic system: faster pulling with less effort.
- 4 jaw positions.
- Point protector included for a better use.
- Possibility of 2 or 3 legs pulling.
- The pull out improves thanks to the three jaws.

Ref.	TON		Hydraulic part	Mechanical part
3318THXO	20	62,0	00918	1318THXO
3330THXO	30	85,0	00930	1330THXO
3352THXO	50	178,0	00952	1352THXO

SERIE 1300THA MECHANICAL PART

1300THA



Mechanical part of serie 3300THA.
External 3 selfcentering jaws puller.
Long jaws (3 holes).



Bullet points

- Automatic selfcentering of the jaws, for a better grip.
- 2 or 3 legs pulling.
- Point protector included for a better use.
- The pull out improves thanks to the three jaws.



Ref.					TON	Position		Spare part		
								Jaw	Spindle	Point protector
1310THA	315	350	60	177	10	2/3 jaws	14,5	131006	111083	111037
1318THA	320	480	80	276	20	3 jaws	33,0	131706	111883	111837
1330THA	410	650	100	325	30	3 jaws	56,5	133006	113083	113037
1352THA	710	980	150	414	50	3 jaws	122,0	135206	115283	113037
1395THA	1000	1600	300	597	100	3 jaws	322,0	139506	119583	119537

SERIE 3300THA COMPLETE HYDRAULIC PULLER

3300THA



Complete puller: mechanical part + hydraulic part.
External 3 jaws selfcentering hydraulic puller.
Long jaws (3 holes).



Bullet points

- Hydraulic system: faster pulling with less effort.
- 3 jaw positions.
- Point protector included for better use.
- Better grip thanks to the automatic centering of the legs.
- The pull out improves thanks to the three jaws.

Ref.		Hydraulic part	Mechanical part
3310THA	35,0	00910	1310THA
3318THA	66,0	00918	1318THA
3330THA	81,0	00930	1330THA
3352THA	177,0	00952	1352THA
3395THA	465,0	00995	1395THA



SERIE 1300THXA MECHANICAL PART 1300THXA



Mechanical part of serie 3300THXA.
External 3 jaws puller.
Extra long jaws (4 holes).



Bullet points

- Automatic selfcentering of the jaws, for a better grip.
- 4 jaw positions.
- Point protector included for a better use.
- The pull out improves thanks to the three jaws.

Ref.					TON	Position		Spare part		
								Jaw	Spindle	Point protector
1310THXA	395	410	60	176	10	2/3 jaws	16,0	131016	111083	111037
1318THXA	435	540	80	276	20	3 jaws	36,0	131716	111883	111837
1330THXA	535	720	100	325	30	3 jaws	62,5	133016	113083	113037
1352THXA	860	1080	150	414	50	3 jaws	131,0	135216	115283	113037

SERIE 3300THXA COMPLETE HYDRAULIC PULLER 3300THXA



Complete puller: mechanical part + hydraulic part.
External 3 jaws selfcentering puller.
Extra long jaws (4 holes).



Bullet points

- Hydraulic system: faster pulling with less effort.
- Better grip thanks to the automatic centering of the jaws.
- 4 jaw positions.
- Point protector included for better use.

Ref.	TON		Hydraulic part	Mechanical part
3310THXA	10	36,0	00910	1310THXA
3318THXA	20	69,0	00918	1318THXA
3330THXA	30	87,0	00930	1330THXA
3352THXA	50	187,0	00952	1352THXA



SERIE 1300THACO MECHANICAL PART

1300THACO







Mechanical part of 3300THACO hydraulic set.
External self-centering puller with 2 and 3 jaws.
Long jaws (3 holes).
2 jaws body included.



Bullet points

- Automatic centering of the extraction jaws, for a better grip
- 3 jaw positions.
- Point protector included for better use.
- Possibility of extraction with 2 or 3 jaws.
- The pull out improves thanks to the three jaws.

Ref.					TON		Spare part		
							Spindle	Jaw	Point protector
1318THACO	320	480	80	276	20	24,7	111883	131706	111837
1330THACO	410	650	100	325	30	47,1	113083	133006	113037
1352THACO	710	980	150	414	50	103,2	115283	135206	113037
1395THACO	1000	1600	300	597	100	277,3	119583	139506	119537

SERIE 3300THACO COMPLETE HYDRAULIC PULLER

3300THACO



Complete puller with hydraulic part included.
Self-centering with 2 and 3 jaws.
Long jaws (3 holes).
2 jaws body included.



Bullet points

- Hydraulic system: faster pulling with less effort.
- Better grip thanks to the automatic centering of the jaws.
- 3 jaw positions.
- Point protector included for better use.
- Possibility of extraction with 2 or 3 jaws

Ref.	TON		Hydraulic part	Mechanical part
3318THACO	20	69,0	00918	1318THACO
3330THACO	30	86,0	00930	1330THACO
3352THACO	50	184,0	00952	1352THACO
3395THACO	100	357,0	00995	1395THACO



SERIE 1300THAXO MECHANICAL PART 1300THAXO



Mechanical part of 3300THAXO hydraulic set.
External self-centering puller with 2 and 3 jaws.
Extra long jaws (4 holes).
2 jaws body included.



Bullet points

- Automatic centering of the extraction jaws, for a better grip.
- 4 jaw positions.
- Point protector included for better use.
- Possibility of extraction with 2 or 3 jaws.
- The pull out improves thanks to the three jaws.

Ref.					TON		Spare parts		
							Spindle	Jaw	Point protector
1318THAXO	435	540	80	276	20	27,9	111883	131716	111837
1330THAXO	535	720	100	325	30	53,4	113083	133016	113037
1352THAXO	860	1080	150	414	50	113,4	115283	135216	113037

SERIE 3300THAXO COMPLETE HYDRAULIC PULLER 3300THAXO



Complete puller with hydraulic part included.
3 jaws hydraulic external puller.
Extra long jaws (4 holes).
2 jaws body included.



Bullet points

- Hydraulic system: faster pulling with less effort.
- Better grip thanks to the automatic centering of the jaws.
- 4 jaw positions.
- Point protector included for better use.
- Possibility of extraction with 2 or 3 jaws.

Ref.	TON		Hydraulic part	Mechanical part
3318THAXO	20	72,0	00918	1318THAXO
3330THAXO	30	92,0	00930	1330THAXO
3352THAXO	50	194,0	00952	1352THAXO



COMPLETE 100 TON PULLER TROLLEY

9731000

It consists of the 970100 trolley plus the 3395THA hydraulic puller.
 Pump for puller ref. 1395THA (09522): two-speed pump. Maximum pressure 700 bar.
 Pump to raise the cart (09102) : single speed manual pump. Maximum pressure 700 bar.
 Spindle with manual handwheel to change the angle of the extractor.
 The puller can be removed from the trolley to use it separately.
 Equipped with profiles to use load bulls and with slings to load with a crane.



Trolley with pumps

Ref.	Carriage length (mm)	Carriage width (mm)	Puller minimum height (mm)	Puller maximum height (mm)	Pump		Mechanical part	Puller
973100	2070	936	895	1250	Included	590,0	1395THA	3395THA

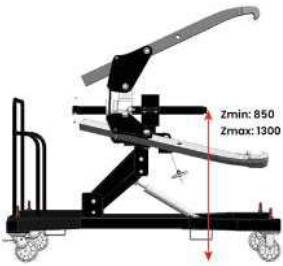

Trolley without pumps

Ref.	Carriage length (mm)	Carriage width (mm)	Puller minimum height (mm)	Puller maximum height (mm)	Pump		Mechanical part	Puller
973099	2070	936	895	1250	Not included	625,0	1395THA	3395THA

100 TON PULLERS TROLLEY

970100

Made for use with FORZA 100ton puller.
 Make the use of the puller more comfortable.



Ref.	
970100	200,0



HYDRAULIC BOLT PULLER

4200H

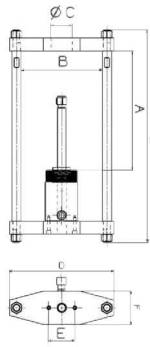

Specially designed to extract large bolts. It uses the same hydraulic part as the pullers. Available in 30 and 60 tons.



Bullet points

- Hydraulic system: faster pulling with less effort.

Ref.	A (Useful jaw height)	B (Maximum opening)	C (Body width)	XC	E	F	L	⚖️
4230H	420	288	370	75	92,1	118	750	35,7
4260H	475	398	520	98	130,1	170	900	96,5

COMPLETE HYDRAULIC BOLT PULLER

4230HC0



Specially designed to remove large bolts. It includes the same hydraulic part as for the others hydraulic pullers. Available in 30 and 60 tons.



Bullet points

- Hydraulic system: faster pulling with less effort.

Ref.	⚖️	Hydraulic part	Mechanical part	Point protector
4230HC	57,0	00930	4230H	113037
4260HC	128,0	00952	4260H	113037

EXPERTS IN EXTRACTORS!

consult solutions for customized extractions



SERIE 1500H INTERNAL PULLER

1500H





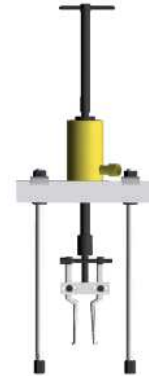

Internal puller.
With regulation spindle to place the jaws.
This puller combines with the hydraulic push pullers of the serie 1100H.

Bullet points

- With adjustment spindle to position the jaws.



Ref.	 A	 B _{max}	 B _{min}	 C	Thread		Mechanical part	Spare part	
								Spindle	Jaw
1506H10	115	145	40	133	3/4" UNF 16H	2,5	1110H	150622	150605
1506H20	115	145	40	133	1" UNC 8H	2,4	1118H	150622	150605
1507H10	140	160	32	133	3/4" UNF 16H	2,7	1110H	150622	150705
1507H20	140	160	32	133	1" UNC 8H	2,6	1118H	150622	150705
1509H30	150	240	60	202	1 1/4" UNC 7H	6,3	1130H	150922	150905
1509H50	150	240	60	202	1 5/8" UNC 5.5H	6,6	1152H	150922	150905

SERIE 4704H 3 EXTERNAL AND INTERNAL JAWS PULLER



4704H

External and internal 3 jaw puller.
With 2 sets of 3 jaws.
470405 is the jaw for internal and external use with a diameter bigger than 97mm.
470415 is the leg for indoor use with a maximum diameter of 97mm.
Combines with push pullers of serie 1100H.

Bullet points

- Perfect for cylinder liners.
- Self-centering system: automatic centering of the jaws for a better grip.



Ref.	 \varnothing _{int}	 \varnothing _{int}	Thread	A (Useful jaw height) with 470205	A (Useful jaw height) with 470215		Spare part		
							Mechanical part	Internal jaw	External jaw
4704H10	45-97	90-152	3/4"16h	135	75	3,1	1110H	470415	470405
4704H20	45-97	90-152	1"8h	135	75	3,1	1118H	470415	470405



SERIE 4708H INTERNAL JAWS PULLER

4708H



3 jaws internal puller.
Combines with push pullers of serie 1100H.



Bullet points

- Perfect for cylinder liners.
- Self-centering system: automatic centering of the jaws for a better grip.



Ref.		Useful jaw height		Thread	Body diameter		Mechanical part	Spare part	
								Jaw	Spindle
4708H30	300	315	130	150	1 1/4"7h	10,8	1130H	150905	470885
4708H50	300	315	130	150	1 5/8"5,5h	11,2	1152H	150905	470886
4708H95	300	315	130	150	2 1/2" 8h	12,0	1195H	150905	470896
4709H95	320	315	130	168	2 1/2"8h	14,2	1195H	150905	470989

ADJUSTING SPLINDES SERIES 4704H-4708H-4709H



Ref.	R (Conection)	L (Length)	C (Distance between faces)	
470485	3/4" 16h	122	32	0,6
470486	1" 8h	122	34	0,6
470885	1 1/4" UNC 7h	215	50	1,9
470886	1 5/8" UNC 5,5h	220	60	2,2
470896	2 1/2" 8h	215	50	3,4
470989	2 1/2" 8h	220	60	0,1

SPINDLES FOR HYDRAULIC PULLERS WITH HANDLE



Ref.	R (Conection)	L (Length)	Head	Point	
101883	1" UNC 8h	540	Handle	Fixed	1,7
111883	1" UNC 8h	670	Handle	Fixed	2,4
113083	1 1/4" UNF 7h	790	Handle	Fixed	4,6
115283	1 5/8" USN 5,5h	975	Handle	Fixed	9,0
111083	3/4" UNF 16h	400	Handle	Fixed	0,8



HYDRAULIC BALL BEARING PULLER MECHANICAL PART

1700-6H0

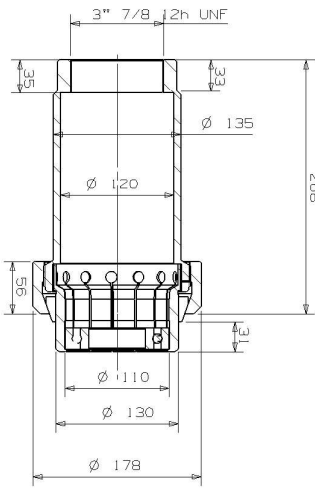

This extractor allows to mount and dismount all types of bearings. For this extractor, collets that are made to measure for the bearing to be extracted are adapted. The price is for each collet, each collet extracts a different bearing. Hydraulic part not included.





Bullet points

- Allows to assemble and disassemble ball bearings but also conical and cylindrical roller bearings that are highly complex to extract.
- Extraction collets are available for the following bearings. If the collets is not in the catalog, we manufactured under request.
- An opener is included to dismount the collets from the bearing after the extraction.

Ref.	TON		Hydraulic part	Point protector	Pinzas
1700-6H		12,0	00918	111837	176018 - 176019
					176020 - 176021
					176022 - 176218
					176219 - 176220
					176221 - 176222
1700-6H5		15,0	00904	111837	1732216 - 1732217
					1732218 - 1732219
					1732220 - 1732222
					1732314 - 1732315
1700-6H10		16,0	00918	111837	1732316 - 1732317
					1732920 - 1732922
					1733021 - 1733217

COLLETS FOR BALL BEARINGS



Ref.	Bearing to remove		Ref.	Bearing to remove	
176018	6018	0,1	1732219	32219	5,0
176019	6019	0,1	1732220	32220	5,0
176020	6020	0,1	1732222	32222	5,0
176021	6021	0,1	1732314	32314	5,0
176022	6022	0,1	1732315	32315	5,0
176218	6218	0,1	1732316	32316	5,0
176219	6219	0,1	1732317	32317	3,1
176220	6220	0,1	1732920	32920	3,8
176221	6221	0,1	1732922	32922	5,5
176222	6222	0,1	1733021	33021	5,0
1732216	32216	5,0	1733217	33217	4,1
1732217	32217	5,0			
1732218	32218	5,0			



COMPLETE HYDRAULIC BALL BEARING PULLER

3700-6H0

This extractor allows to mount and dismount all types of bearings. For this extractor, collets that are made to measure for the bearing to be extracted are adapted. The price is for each collet, each collet extracts a different bearing. Hydraulic part included.



Bullet points

- Allows to assemble and disassemble ball bearings but also conical and cylindrical roller bearings that are highly complex to extract.
- Extraction collets are available for the following bearings. If the collets is not in the catalog, we manufactured under request.
- An opener is included to dismount the collets from the bearing after the extraction.



Ref.	TON		Hydraulic part	Mechanical part Parte mecánica
3700-6H5	5	32,0	00904	1700-6H5
3700-6H10	10	39,0	00909	1700-6H10
3700-6H	20	45,0	00918	1700-6H

WATCH VIDEO



COMPLETE HYDRAULIC PULLER SERIE C1008

C1000



Ref.	Push puller	Puller	Splitter	
C1008	1110HF	1307LTH	1204B	10,5
C1009	1120HF	1310LTH	1206B	29,0

SERIE C3008 COMPLETE HYDRAULIC PULLER

C3000



Allow three types of uses:
 -2/3 oscilating jaws puller.
 -2 fix jaws pullers
 -Push puller and splitter.
 Point extension included.

Ref.	TON		Hydraulic part	Mechanical part	Splitter
C3008	5	29,0	00904	1108HF 1307LTH	1204B
C3009	10	50,0	00909	1120HF 1310LTH	1206B

Hydraulic part



Cylinder Hose Pump Manometer

Mechanical part

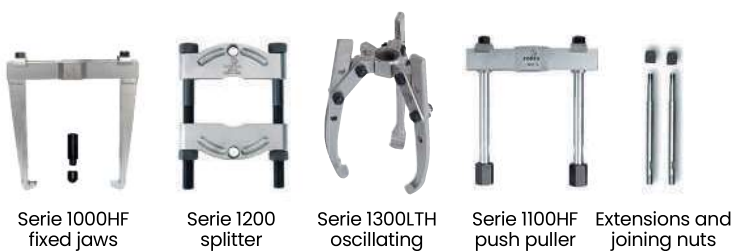

Serie 1000HF fixed jaws Serie 1200 splitter Serie 1300LTH oscillating Serie 1100HF push puller Extensions and joining nuts

Can be mounted

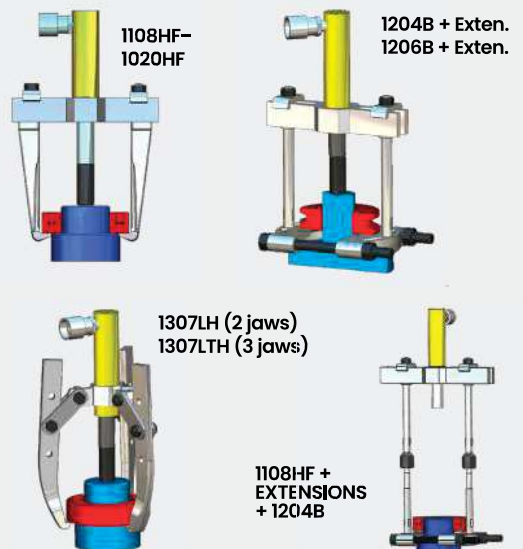

1108HF-1020HF

1204B + Exten.
1206B + Exten.

1307LH (2 jaws)
1307LTH (3 jaws)

1108HF + EXTENSIONS + 1204B



SERIE CP MECHANICAL PART



Ref.	Push puller	Splitter	Internal puller	2 and 3 jaws puller	TON	⚖️	Spare part
							Point protector
C0-10	1110H	1204B	1506H10	1310TH	12	37,0	111037
C1-18	1118H	1206B	1506H20	1318TH	20	61,0	111837
C2-30	1130H	1210C	1509H30	1330TH	30	132,0	113037
C3-45	1125H	1210D	1509H30	1352TH	60	273,0	113037
C3-50	1152H	1212D	1509H50	1352TH	60	303,0	113037
C3-52	1152H	1213D	1509H50	1352TH	6060	283,0	113037

SERIE CP COMPLETE HYDRAULIC SET



CP complete hydraulic set.

In addition to the puller described in the table, it includes:

- 2 pairs of extra extensions.
- 2 link nuts.
- Point protector.



Bullet points

- Hydraulic system: faster pulling with less effort.
- Versatility: with one set you can have many possibilities of extractions.
- Palletized black metal box.



Can be mounted

Ref.	TON	⚖️	Hydraulic part	Mechanical part
CP-10	12	54,0	00910	C0-10
CP-20	20	83,0	00918	C1-18
CP-30	30	153,0	00930	C2-30
CP-45	60	227,0	00952	C3-45
CP-50	60	257,0	00952	C3-50

Hydraulic part

Pump
Cylinder
Hose
Manometer

Mechanical part

Serie 1300TH self-centering
Serie 1200 Splitter
Serie 1500H internal puller
Serie 1100H Push puller
Extensions and body

SERIE CPA MECHANICAL PART

CMA



Ref.	Push puller	Splitter	Internal puller	2 and 3 jaws self centering puller	TON	⚖️	Spare part
							Point protector
C0-10A	1110H	1204B	1506H10	1310THA	12	42,0	111037
C1-18A	1118H	1206B	1506H20	1318THA	20	77,0	111837
C2-30A	1130H	1210C	1509H30	1330THA	30	142,0	113037
C3-45A	1152H	1210D	1509H30	1352THA	60	259,0	113037
C3-50A	1152H	1212D	1509H50	1352THA	60	281,0	113037
C3-52A	1152H	1213D	1509H50	1352THA	60	318,0	113037
C4-95A	1195H	1213E	4709H95	1395THA	100	574,0	119537

SERIE CPA COMPLETE HYDRAULIC SET

CPA



CPA complete hydraulic set.
 In addition to the puller described in the table, it includes:
 - 2 pairs of extra extensions.
 - 2 link nuts.
 - Point protector.



Bullet points

- Hydraulic system: faster pulling with less effort.
- Versatility: with one set you can have many possibilities of extractions.
- Automatic centering of the jaws, for a better grip.
- Palletized black metal box.

Can be mounted

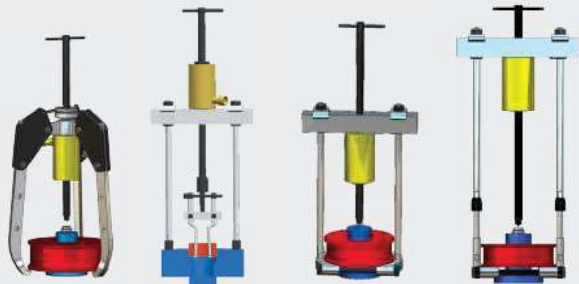

Ref.	TON	⚖️	Hydraulic part	Mechanical part
CP-10A	12	56,0	00910	C0-10A
CP-20A	20	95,0	00918	C1-18A
CP-30A	30	160,0	00930	C2-30A
CP-45A	60	305,0	00952	C3-45A
CP-50A	60	361,0	00952	C3-50A
CP-52A	60	370,0	00952	C3-52A
CP-95A	100	667,0	00995	C4-95A

Hydraulic part



Mechanical part





SERIE CPN COMPLETE HYDRAULIC SET



Ref.	Push puller	Splitter	2 and 3 jaws puller	TON	Scales	Spare part
						Point protector
C0-10N	1110H	1204B	1310TH	12	31,0	111037
C1-18N	1118H	1206B	1318TH	20	54,0	111037
C2-30N	1130H	1210C	1330TH	30	116,0	111837
C3-45N	1152H	1210D	1352TH	50	199,0	113037
C3-50N	1152H	1212D	1352TH	50	217,0	113037

SERIE CPN COMPLETE HYDRAULIC PULLER



CPN complete hydraulic set.
 In addition to the puller described in the table, it includes:
 - 2 pairs of extra extensions.
 - 2 joining nuts.
 - Point protector.



Bullet points

- Hydraulic mechanism: faster pulling with less effort.
- Versatility: with one set you can have many possibilities of extractions.
- Palletized black metal box.



Ref.	TON	Scales	Hydraulic part	Mechanical part
CP-10N	12	47,0	00910	C0-10N
CP-20N	20	91,0	00918	C1-18N
CP-30N	30	137,0	00930	C2-30N
CP-45N	50	260,0	00952	C3-45N
CP-50N	50	278,0	00952	C3-50N

Hydraulic part



Mechanical part



SERIE XP MECHANICAL PART



Spare part

Ref.	Push puller	Splitter	Internal puller	2 and 3 jaws extra long puller	TON		Point protector
X0-10	1110H	1204B	1506H10	1310THX	12	40,5	111037
X1-18	1118H	1206B	1506H20	1318THX	20	67,5	111837
X2-30	1130H	1210C	1509H30	1330THX	30	136,0	113037
X3-45	1125H	1210D	1509H30	1352THX	50	248,8	113037
X3-50	1152H	1212D	1509H50	1352THX	50	262,3	113037

SERIE XP COMPLETE HYDRAULIC SET



XP complete hydraulic set.
In addition to the puller described in the table, it includes:
- 2 pairs of extra extensions.
- 2 joining nuts.
- Point protector.



Bullet points

- Hydraulic system: faster pulling with less effort
- Versatility: with one set you can have many possibilities of extractions.
- Palletized black metal box.
- Extra large jaws.



Can be mounted

Ref.	TON		Hydraulic part	Mechanical part
XP-10	12	67,7	00910	X0-10
XP-20	20	103,5	00918	X1-18
XP-30	30	187,5	00930	X2-30
XP-45	50	291,8	00952	X3-45
XP-50	50	303,0	00952	X3-50

Hydraulic part



Mechanical part





SERIE KP MECHANICAL PART

KPM



Ref.	Push puller	Splitter	Internal puller	TON	⚖️	Spare part
						Point protector
K0-10	1110H	1204B	1506H10	12	27,0	111037
K1-18	1118H	1206B	1506H20	20	38,0	111837
K2-30	1130H	1210C	1509H30	30	80,0	113037
K3-45	1152H	1210D	1509H30	50	138,2	113037
K3-50	1152H	1212D	1509H50	50	151,7	113037
K4-95	1195H	1213E	4709H95	100	280,3	119537

SERIE KP COMPLETE HYDRAULIC PULLER

KP



KP complete hydraulic set.

In addition to the puller described in the table, it includes:

- 1 pair of extra extensions
- 2 link nuts.
- Point protector.



Bullet points

- Hydraulic system: faster pulling with less effort
- Versatility: with one set you can have many possibilities of extractions
- Palletized black metal box

Can be mounted



Ref.	TON	⚖️	Hydraulic part	Mechanical part
KP-10	12	54,2	00910	K0-10
KP-20	20	70,0	00918	K1-18
KP-30	30	119,0	00930	K2-30
KP-45	50	181,2	00952	K3-45
KP-50	50	194,7	00952	K3-50
KP-95	100	358,3	00995	K4-95

Hydraulic part



Mechanical part

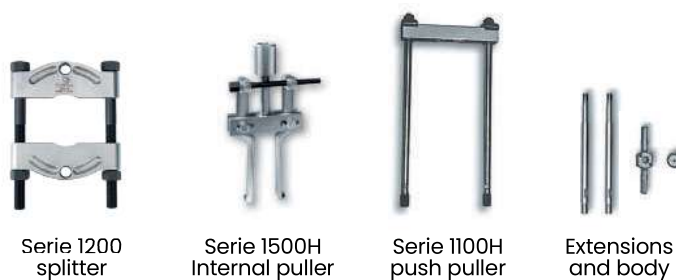

SERIE 1300CTA SELF CENTERING HYDRAULIC RAM PULLER

1300CTA







Self centering hydraulic ram puller with pump and cilinder integrated. Long jaws (3 holes).



Bullet points

- Hydraulic system: faster pulling with less effort.
- Hydraulic ram spindle. It does not require a hydraulic pump.
- Self-centering system: automatic centering of the jaws for a better grip.
- The pull out improves thanks to the three jaws.

Ref.					Combines	TON		Spare part	
								Jaw	Hydraulic spindle
1306CLTA	380	360	50	220	2/3 jaws	6	15,1	131006	00806
1306CTA	300	310	50	220	2/3 jaws	6	14,2	131005	00806
1306CXTA	460	410	50	220	2/3 jaws	6	16,3	131016	00806
1308CLTA	485	480	70	205	-	8	23,8	131706	00808
1308CTA	370	425	70	205	-	8	21,7	131705	00808
1308CXTA	600	540	70	205	-	8	27,0	131716	00808

SERIE 1300CTH WITH PUMP AND CYLINDER

1300CTH





Hydraulic ram puller with pump and cilinder integrated. Long jaws (3 holes).



Bullet points

- Hydraulic system: faster pulling with less effort.
- Hydraulic ram spindle. It does not require a hydraulic pump.
- The pull out improves thanks to the three jaws.

Ref.			TON	Combines		Spare part	
						Complete jaw	Hydraulic spindle
1306CLTH	380	360	6	2/3 Jaws	11,2	131060	00806
1306CTH	300	310	6	2/3 Jaws	10,2	131050	00806
1306CXTH	460	410	6	2/3 Jaws	13,6	131066	00806
1308CLTH	485	480	8	-	21,5	131760	00808
1308CTH	370	425	8	-	19,5	131750	00808
1308CXTH	600	540	8	-	23,5	131766	00808



SERIE 1010H FORZA HYDRAULIC RAM PULLER 1010H0









8Tn hydraulic fixed jaw puller.
For external and internal.
Use the handle to apply hydraulic force.
Do not use wrenches or levers to tighten the sub-spindle.

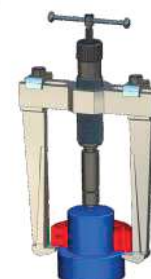

Bullet points

- Hydraulic system: faster pulling with less effort. The force is applied directly to the body.
- Faster assembly.



Ref.						Spare part	
						Hydraulic spindle	Complete jaw
1010AH	160	195	60	260	5,0	150000E	101050
1010H	160	150	60	210	4,7	150000E	101050
1010LAH	220	195	60	260	5,8	150000E	101060
1010LH	220	150	60	210	5,5	150000E	101060

SERIE 1018H FORZA 2 JAW PUSH PULLER 1108H0



8 Tn hydraulic puller with 2 extensions.
This puller combines with 1200 splitters.
Use the handle to apply hydraulic force.
Do not use wrenches or levers to tighten the sub-spindle.







RECOMMENDATION

The extension should be as close as possible to the pulley. The pulley should touch the extensions. This will prevent the extensions from bending.

Bullet points

- Hydraulic system: faster pulling with less effort.
- The force is applied directly to the body.

Ref.				Combines		Spare part	
						Hydraulic spindle	Point protector
1108AH	190	250	260	1204B	4,8	150000E	111037
1108H	190	200	210	1206B	4,3	150000E	111037

SERIE 1308TH 8 TONS HYDRAULIC PULLER

1308TH





8Tn hydraulic 3 jaw puller.
Use the handle to apply hydraulic force.
Do not use wrenches or levers to tighten the sub-spindle.
Jaws 3 holes.



Bullet points

- Hydraulic system: faster pulling with less effort.
- The force is applied directly to the body.
- 2 or 3 legs pulling.
- The pull out improves thanks to the three jaws.

Ref.			TON		Spare part	
					Hydraulic spindle	Complete jaw
1308TH	225	260	8	5,1	150000E	130760

SERIE 1308THA SELF CENTERING HYDRAULIC RAM PULLER

1308THA





8Tn hydraulic oscilating jaw puller.
Use the handle to apply hydraulic force.
Do not use wrenches or levers to tighten the sub-spindle.



Bullet points

- Hydraulic system: faster pulling with less effort.
- The force is applied directly to the body.
- Self-centering system: automatic centering of the jaws for a better grip.
- 2 or 3 legs pulling.
- The pull out improves thanks to the three jaws.

Ref.			TON		Spare part	
					Hydraulic spindle	Jaw
1308THA	225	260	8	6,8	150000E	130786

SERIE 7308ALTH SELF CENTERING HYDRAULIC RAM PULLER

7308ALTH





8Tn hydraulic 3 jaw oscilating puller.
Use the handle to apply hydraulic force.
Do not use wrenches or levers to tighten the sub-spindle.



Bullet points

- Hydraulic mechanism: faster pulling with less effort.
- Self-centering system: automatic centering of the jaws for a better grip.
- Possibility of extraction with 2 or 3 legs pulling.
- Safety pin to avoid overloading the spindle.
- The pull out improves thanks to the three jaws.



Ref.			TON		Spare part	
					Jaw	Hydraulic spindle
7308ALTH	270	280	8	7,5	730786	150000E



SERIE 1012H FORZA HYDRAULIC RAM PULLER 1012H0



12Tn hydraulic fixed jaw puller.
For external and internal.
Do not use wrenches or levers to tighten the sub-spindle.



Bullet points

- Hydraulic system: faster pulling with less effort.
- The force is applied directly to the body
- Faster assembly.
- Safety pin to avoid overloading the spindle.

Ref.					Spare part	
					Hydraulic spindle	Complete jaw
1012AH	160	195	260	5,2	150120	101050
1012H	160	150	210	4,9	150120	101050
1012LAH	220	195	260	5,9	150120	101060
1012LH	220	150	210	5,6	150120	101060

SERIE 1312TH HYDRAULIC RAM PULLER 1312TH



12Tn hydraulic 3 jaw puller.
Tighten the sub-spindle with a 17mm spanner.
Do not use wrenches or levers to tighten the sub-spindle.



Bullet points

- Hydraulic system: faster pulling with less effort
- More rigidity in extraction: force is applied directly to the body
- Possibility of extraction with 2 or 3 legs pulling.
- Safety pin to avoid overloading the spindle.
- The pull out improves thanks to the three jaws.

Ref.				Spare part	
				Hydraulic spindle	Complete jaw
1312TH	225	260	5,2	150120	130760

SERIE 1312THA SELF CENTERING HYDRAULIC RAM PULLER 1312THA

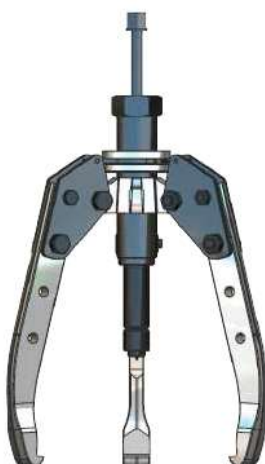

12Tn hydraulic oscilating puller.
Tighten the sub-spindle with a 17mm spanner.
Do not use wrenches or levers to tighten the sub-spindle.



Bullet points

- Hydraulic mechanism: faster pulling with less effort.
- Self-centering system: automatic centering of the jaws for a better grip.
- Possibility of extraction with 2 or 3 legs pulling.
- Safety pin to avoid overloading the spindle.
- The pull out improves thanks to the three jaws.

Ref.				Spare part	
				Hydraulic spindle	Jaw
1312THA	225	260	7,6	150120	130786

SERIE 7312ALTH SELF CENTERING HYDRAULIC RAM PULLER

7312ALTH





12Tn hydraulic oscilating jaw puller.
Tighten the sub-spindle with a 17mm spanner.
Do not use wrenches or levers to tighten the sub-spindle.



Bullet points

- Hydraulic system: faster pulling with less effort.
- Self-centering system: automatic centering of the jaws for a better grip.
- Possibility of extraction with 2 or 3 legs pulling.
- Safety pin to avoid overloading the spindle.
- The pull out improves thanks to the three jaws.



Ref.				Spare part	
				Jaw	Hydraulic spindle
7312ALTH	270	280	7,6	730786	150120

SERIE 1016H FORZA HYDRAULIC RAM PULLER

1016H0







16Tn hydraulic fixed jaw puller.
For external and internal.
Do not use wrenches or levers to tighten the sub-spindle.



Bullet points

- Hydraulic system: faster pulling with less effort.
- The force is applied directly to the body.
- Faster assembly.
- Safety pin to avoid overloading the spindle.

Ref.					Spare part		
					Hydraulic spindle	Complete jaw	Point protector
1016AH	160	390	475	15,0	101683	102050	111037
1016H	160	250	345	12,5	101683	102050	111037
1016LAH	290	390	475	17,5	101683	102060	111037
1016LH	290	250	345	15,5	101683	102060	111037
1016XH	160	600	675	22,0	101683	102050	111037
1016XLH	290	600	675	25,0	101683	102060	111037



HYDRAULIC PULLER SET C1004-C1006

C10040



8 tones hydraulic puller set with compact spindle.
For external and internal use.
Do not use wrenches or levers to tighten the sub-spindle.
They are supplied in a cardboard box.



Bullet points

- Hydraulic system: faster pulling with less effort.
- The force is applied directly to the body.
- Faster assembly.

Ref.	Puller	Long puller	Splitter	Push puller	⚖️
C1004	1010H	1010LH	1204B	1108H	11,3
C1006	1010AH	1010LAH	1206B	1108AH	15,0

HYDRAULIC PULLER SET C1005-C1012

C10050



8 and 12 Tons hydraulic puller set with compact spindle
For external and internal use.
Do not use wrenches or levers to tighten the sub-spindle
They are supplied in a red case.



Bullet points

- Hydraulic system: faster pulling with less effort.
- The force is applied directly to the body.
- Faster assembly.

Ref.	Puller	Long puller	Splitter	Push puller	TON	⚖️
C1005	1308TH	1010LH	1204B	1108H	8	14,5
C1012	1312TH	1012LH	1204B	1108AH	12	15,0



SERIE 1116H PUSH PULLER AND HYDRAULIC RAM PULLER

1116H0

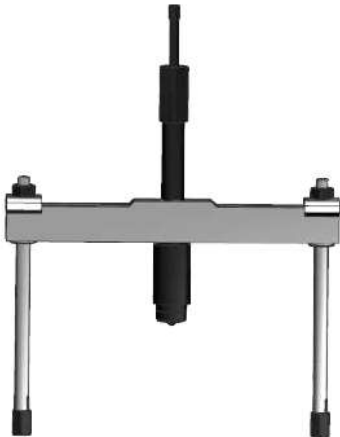

16Tn hydraulic puller with 2 extensions.
This puller combine with 1200 splitters
Do not use wrenches or levers to tighten the sub-spindle.



RECOMMENDATION

The extension should be as close as possible to the pulley. The pulley should touch the extensions. This will prevent the extensions from bending.

Bullet points

- Hydraulic system: faster pulling with less effort.
- The force is applied directly to the body.

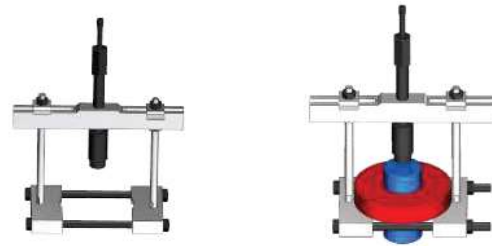

Ref.					Combines		Spare part		
							Hydraulic spindle	Extender	Point protector
1116AH	155	445	173	475	1208B	13,8	101683	112080	111037
1116H	155	325	105	345	1206B	11,4	101683	112080	111037

SERIE 1315TH SELF CENTERING HYDRAULIC RAM PULLER

1315TH0



16Tn hydraulic 3 jaws puller.
Standard jaws (2 holes), long jaws L (3 holes) and extra long jaws X (4 holes).
Tighten the sub-spindle with a 17mm spanner.
Do not use wrenches or levers to tighten the sub-spindle.



Bullet points

- Hydraulic system: faster pulling with less effort.
- The force is applied directly to the body.
- Safety pin to avoid overloading the spindle.
- The pull out improves thanks to the three jaws.

Ref.				Spare part		
				Hydraulic spindle	Complete jaw	Point protector
1315LTH	385	480	23,0	101683	131750	111037
1315TH	265	425	20,0	101683	131750	111037
1315XTH	500	540	25,0	101683	131760	111037



SERIE 1315ATH SELF CENTERING HYDRAULIC RAM PULLER 1315ATH0



16Tn hydraulic oscilating puller.
 Standard jaws (2 holes), long jaws L (3 holes) and extra long jaws X (4 holes).
 Tighten the sub-spindle with a 17mm spanner.
 Do not use wrenches or levers to tighten the sub-spindle.



Bullet points

- Hydraulic system: faster pulling with less effort.
- Self-centering system: automatic centering of the jaws for a better grip.
- Safety pin to avoid overloading the spindle.
- The pull out improves thanks to the three jaws.

Ref.				Spare part		
				Hydraulic spindle	Jaw	Point protector
1315ATH	265	425	29,0	101683	131705	111037
1315ALTH	385	480	32,0	101683	131706	111037
1315AXTH	500	540	35,0	101683	131716	111037

SERIE 2400H SELF CENTERING HYDRAULIC RAM PULLER 2400H



16 Tn hydraulic fixed puller.
 Forged jaws with hexagonal spindle .
 Do not use wrenches or levers to tighten the sub-spindle.



Bullet points

- Hydraulic system: faster pulling with less effort.
- The force is applied directly to the body.
- Faster assembly.
- Safety pin to avoid overloading the spindle.

Ref.					Spare part		
					Hydraulic spindle	Complete jaw	Point protector
2430H	100	240	325	9,8	101683	C200	111037
2430LH	280	240	325	11,2	101683	C200	111037
2435H	100	350	425	11,0	101683	C200	111037
2435LH	280	350	425	12,1	101683	C200	111037
2440H	100	510	585	17,0	101683	C375	111037
2440LH	280	510	585	18,0	101683	C375	111037
2450H	125	640	717	29,8	101683	D225	111037
2450LH	250	640	717	28,0	101683	D350	111037



COMPACT HYDRAULIC RAM SPINDLES



Ref.	Length	Power (Tn)	Threaded length	Strap	
00806	340	6	120	70	3,1
00808	360	8	155	85	3,8

8 TON HYDRAULIC RAM SPINDLE



Ref.	R (Conection)	L (Length)	
15000E	1/12" 16h	189	1,5

12 TON HYDRAULIC RAM SPINDLE



Ref.	R (Conection)	L (Length)	C (Distance between faces)	
150120	1/12" 16h	158	17	1,6

15 TON HYDRAULIC RAM SPINDLE



Ref.	R (Conection)	L (Length)	C (Distance between faces)	
101683	1" Gas 11h	460	17	3,4